



Operator's Manual for:

VL955

Vista Series™
Consumer Wheelchair Lifts



"Providing Access to the World"®

International Corporate Hdqrs: P.O. Box 310 Winamac, IN 46996 USA
1-800-THE LIFT (574) 946-6153 FAX: (574) 946-4670



! WARNING



Read manual before operating lift. Failure to do so may result in serious bodily injury and/or property damage. Keep manual in lift storage pouch.

30197

January 2004

Patent #7,413,395

Patent #5,261,779

Patent #5,806,632

Patents Pending

Congratulations

We at The Braun Corporation wish to express our fullest appreciation on your new purchase. With you in mind, our skilled craftsmen have designed and assembled the finest lift available.

This manual includes safety precautions, lift operating instructions, manual operating instructions, and instructions for maintenance and lubrication procedures.

Your lift is built for dependability, and will bring you years of pleasure and independence, as long as maintenance is performed regularly and the lift is operated by an instructed person.

Sincerely,

THE BRAUN CORPORATION

A handwritten signature in black ink that reads "Ralph W. Braun". The signature is written in a cursive style with a prominent initial "R".

Ralph W. Braun
Chief Executive Officer

Contents

Lift Terminology

Lift Terminology Illustration	2
Introduction	3
Direction	3
Lift Components	3, 4
Lift Actions and Functions	5

Lift Operation Safety

Safety Symbols	6
Lift Operation Safety Precautions	7-10

Pre-Lift Operation Notes and Details

General Safety	11, 12
Lift Control Switches	12, 13
Lift Features	
Bridge Plate	14
Automatic Floor Level Switching	14

Automatic Outboard Roll Stop	15, 16
Bridging	16
Handrails	16
Lift Passengers	
Passenger Orientation (Boarding Direction) ...	17
Vehicle (Floor Level) Loading and Unloading	17
Wheelchair-Equipped Occupant Seat Belts	18
Operation Procedure Review	18, 19
Preventive Maintenance	19, 20
Lift Operating Instructions	21-27
Manual Operating Instructions	28-30
Decals and Antiskid	31, 32
Maintenance and Lubrication	33, 34
Warranty and Registration Instructions	35, 36

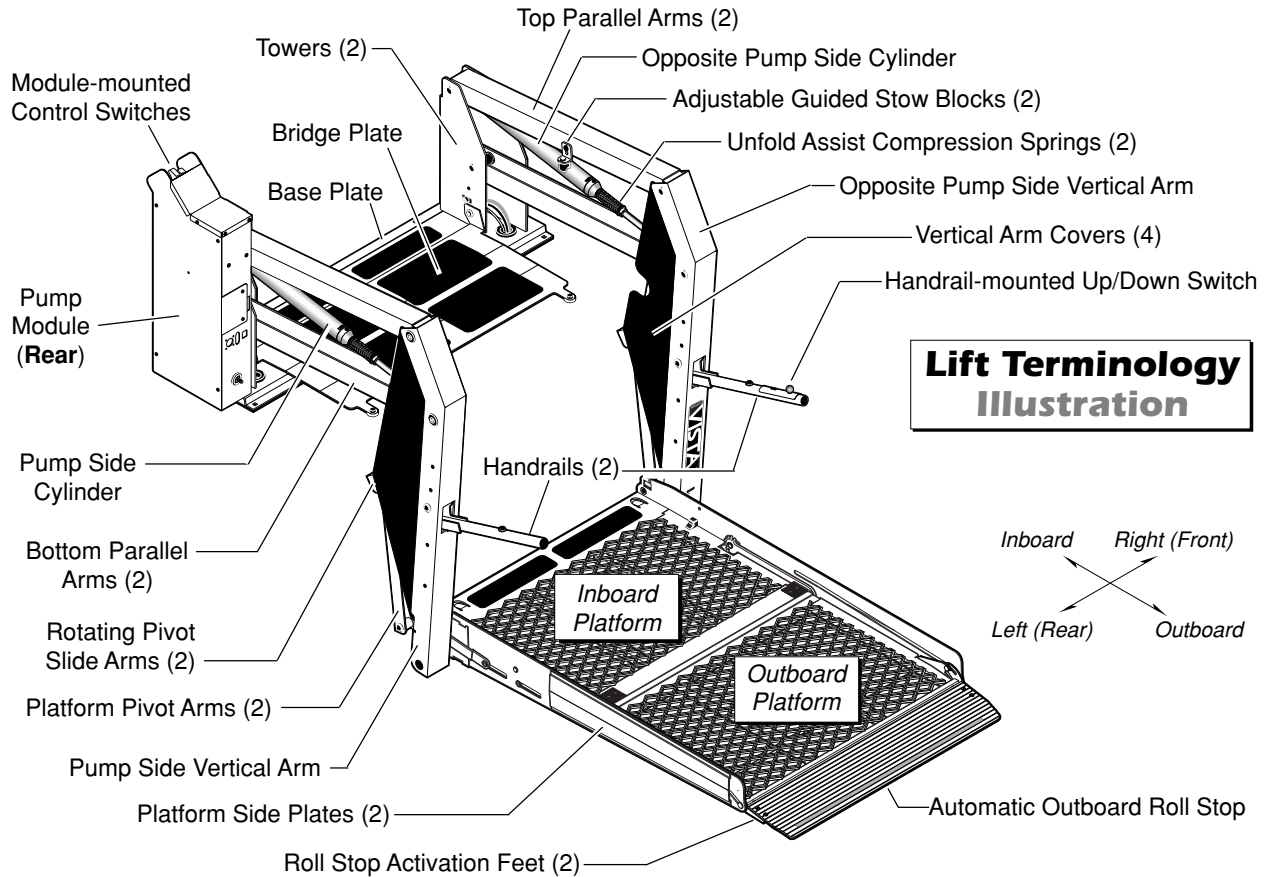

**Lift Terminology
Illustration**

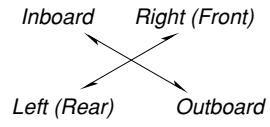

Lift Terminology

Introduction:

Braun VL955 Vista Series lifts are consumer oriented (designed to allow operation by the wheelchair passenger). VL955 lift models provide fully automatic operation of all lift functions as well as optional automatic door operators (if so equipped).

Lift model VL955U3144 is depicted in the Lift Terminology illustration. Lift model numbers indicate platform/roll stop configuration and physical dimensions.

Lift operation procedures are identical for all VL955 Series lift models. The operating instructions contained in this manual and appearing on lift-posted operating instructions decals

address the lift control switches and the corresponding lift functions. Instructions are provided for manual operation of the lift in event of power or equipment failure.

Terminology: Become familiar with the terminology that will be used throughout this manual. Become familiar with the identification of lift components and their functions. Contact your lift sales representative or call The Braun Corporation at 1-800-THE LIFT if any of this information is not fully understood.

Direction: The terms "left (rear)," "right (front)," "inboard," and "outboard" will be used throughout this manual to indicate direction (as viewed from outside

the vehicle looking directly at the lift). Refer to the Lift Terminology Illustration for clarification of direction terms.

Lift Components

Refer to the Lift Terminology Illustration for identification of lift components.

Pump Module: The lift-mounted pump module consists of the hydraulic pump, the manual hand pump and electrical components that power the lift electric/hydraulic systems.

Module-mounted Control Switches: The pump module is equipped with three color-coded and function-labeled control switches (OPEN/CLOSE, IN/OUT

Lift Terminology

Lift Components (continued)

and UP/DOWN). The switches activate the automatic lift functions and optional door operators. Further details are provided in the Pre-Lift Operation section (page 12).

Lift Frame: The lift frame consists of the base plate, two towers, the parallel arms, the vertical arms, platform pivot arms and the handrails. The two main hydraulic cylinders are housed in the parallel arms. The electrical/hydraulic powered lift frame components mechanically unfold, lower, raise and fold the lift platform assembly.

Bridge Plate: The hinged bridge plate assembly bridges the gap

between the lift platform and the vehicle floor when the platform is positioned at floor level.

Dual Handrails: Dual handrails are provided for wheelchair passenger use. The handrails automatically unfold to the deployed position when the platform unfolds and fold automatically to the stowed position when the platform folds. The passenger may choose to grip the handrails when on the lift platform (if applicable). **Note:** An additional UP/DOWN control switch is built into the right (front) handrail.

Platform Assembly: The lift “stacking” platform assembly is made up of an inboard platform section and an outboard platform section (each section consisting

of a steel tubing frame with grating surface). The outboard platform section is equipped with the outboard roll stop.

Automatic Roll Stop: The spring loaded automatic roll stop provides a ramp for wheelchair loading and unloading at ground level. Photos and further details regarding the outboard roll stop are provided in the Pre-Lift Operation Notes and Details section.

Manual Operation System: A manual backup hand pump is built into the pump module. The lift platform can be unfolded, lowered, raised and folded using the hand pump. Manual Operation Instructions are provided on pages 28-30.

Lift Terminology

Lift Actions and Functions

UNFOLD (Out) - Platform

Unfold: Unfold is the action of the platform rotating out and down from the fully-stowed (vertical) position to floor level (horizontal) position when the OUT switch is pressed.

DOWN - Platform Lower: Down is the action of the platform lowering from floor level position to fully-lowered (ground level) position when the DOWN switch is pressed.

DOWN - Roll Stop Unfold (Deploy) - When the platform reaches the fully-lowered (ground) position and the DOWN switch is continued to be pressed, the outboard roll stop

rotates downward from vertical position to ramp position.

UP - Platform Raise: Up is the action of the platform raising from ground level to floor level (fully-raised) position when the UP switch is pressed.

UP - Roll Stop Fold (Raise): As the platform begins to raise off the ground, the spring-loaded roll stop rotates from ramp position to vertical position.

FOLD (In) - Platform Fold: Fold is the action of the platform rotating up and in from the floor level (horizontal) position to fully-stowed (vertical) position when the IN switch is pressed.

Stowed Position: The lift is stowed when the lift platform has been fully raised and folded fully (vertical position).

Floor Level: Floor level is the position (height) the platform assembly reaches in order for the wheelchair passenger to enter and exit the vehicle (fully raised). The platform automatically stops at floor level when unfolding from the stowed position and when raising from ground level.

Note: Further details regarding lift control switches and the corresponding lift functions are provided in the Pre-Lift Operation Notes and Details section.

Lift Operation Safety

Safety Symbols

SAFETY FIRST! Know That ...

A All information contained in this manual and supplements (if included), is provided for your safety. Familiarity with proper operation instructions as well as proper maintenance procedures are necessary to ensure safe, troublefree operation. Safety precautions are provided to identify potentially hazardous situations and provide instruction on how to avoid them.

B



C

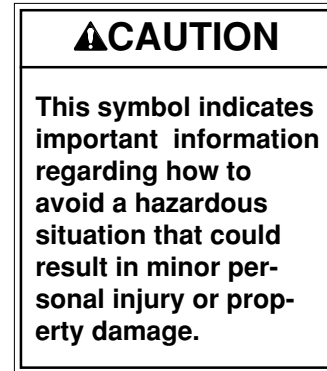

D **Note:** Additional information provided to help clarify or detail a specific subject.

These symbols will appear throughout this manual as well as on the labels posted on your lift. **Recognize the seriousness of this information.**

Lift Operation Safety

Lift Operation Safety Precautions

⚠️ WARNING

If the lift operating instructions, manual operating instructions and/or lift operation safety precautions are not fully understood, contact The Braun Corporation immediately. Failure to do so may result in serious bodily injury and/or property damage.

⚠️ WARNING Read manual and supplement(s) before operating lift. Read and become familiar with all safety precautions, pre-lift operation notes and details, operating instructions and manual operating instructions before operating the lift. **Note:** Wheelchair passengers and all transit agency personnel (drivers and wheelchair lift attendants) must read and become familiar with the contents of this manual and supplement(s) before operation.

⚠️ WARNING Load and unload on level surface only.

⚠️ WARNING Engage vehicle parking brake before operating lift.

⚠️ WARNING Provide adequate clearance outside the vehicle to accommodate the lift before opening lift door(s) or operating lift.

⚠️ WARNING Inspect lift before operation. Do not operate lift if you suspect lift damage, wear or any abnormal condition.

⚠️ WARNING Keep operator and bystanders clear of area in which the lift operates.

Lift Operation Safety

Lift Operation Safety Precautions (continued)

- ▲WARNING** Whenever a wheelchair passenger (or standee) is on the platform, the:
 - Wheelchair brakes must be locked
 - Roll stop(s) must be up (vertical)
 - Passenger should grip both handrails (if able).

- ▲WARNING** Load and unload clear of vehicular traffic.

- ▲WARNING** Do not overload or abuse. The load rating applies to both the raising and lowering functions - continuous lifting capacity is 800 lbs.

- ▲WARNING** Do not operate or board the lift if you or your lift operator are intoxicated.

- ▲WARNING** Do not raise front wheelchair wheels (pull wheelie) when loading (boarding) the platform.

- ▲WARNING** Open lift door(s) fully and secure before operating lift.

- ▲WARNING** Position and secure (buckle, engage, fasten, etc.) the wheelchair-equipped occupant seat belt (torso restraint) before loading onto the wheelchair lift platform.

- ▲WARNING** Lift attendants must ensure that lift occupants keep hands, arms and all other body parts within the lift occupant area and clear of moving parts.

Lift Operation Safety

⚠️ WARNING

If the lift operating instructions, manual operating instructions and/or lift operation safety precautions are not fully understood, contact The Braun Corporation immediately. Failure to do so may result in serious bodily injury and/or property damage.

- ⚠️ WARNING** Platform must be positioned at floor level (bridge plate height) when loading or unloading in and out of vehicle.
- ⚠️ WARNING** Do not use platform roll stop as a barrier (brake). Stop and brake wheelchair when loading onto the platform (manually stop and brake manual wheelchairs — stop powered wheelchairs with the wheelchair controls).
- ⚠️ WARNING** Turn powered (electric) wheelchairs off when on lift platform.
- ⚠️ WARNING** Press the DOWN switch until the entire platform rests on ground level (lowered fully) and the outboard roll stop is fully unfolded (ramp position) before loading or unloading a passenger at ground level.
- ⚠️ WARNING** Outboard platform roll stop must be fully unfolded (ramp position) until the entire wheelchair crosses roll stop when loading or unloading at ground level.

⚠️ WARNING Accidental activation of control switch(es) may cause unintended operation(s).

⚠️ WARNING Maintenance and lubrication procedures must be performed as specified in this manual by authorized (certified) service personnel.

Lift Operation Safety

Lift Operation Safety Precautions (continued)

- ▲WARNING** Replace missing, worn or illegible decals.
- ▲WARNING** Keep this operator's manual in lift-mounted manual storage pouch when not in use.
- ▲WARNING** Never modify (alter) a Braun Corporation lift.
- ▲WARNING** Do not use accessory devices not authorized by The Braun Corporation.
- ▲WARNING** Do not remove any guards or covers.
- ▲WARNING** Keep clear of any hydraulic leak.
- ▲WARNING** Failure to follow these safety precautions may result in serious bodily injury and/or property damage.

Pre-Lift Operation Notes and Details

WARNING

Read and become familiar with all lift operation safety precautions, pre-lift operation notes and details, operating instructions and manual operating instructions prior to operating the lift. If this information is not fully understood, contact The Braun Corporation immediately. Failure to do so may result in serious bodily injury and/or property damage.

Braun VL955 Vista Series lifts are consumer oriented (designed to allow operation by the wheelchair passenger). VL955 Series lifts are typically installed in vehicles equipped with fully-automatic door operators. The VL955 provides fully automatic operation of all lift functions as well as optional automatic door operators (if so equipped).

Note: An attendant must manually open and close lift door(s) in applications where power door operator(s) are not provided.

It is the responsibility of the lift operator (attendant and/or wheelchair passenger) to properly activate all power (lift and door) functions.

Read and become familiar with all lift operation safety precautions, pre-lift operation notes and details, lift

operating instructions and manual operating instructions before attempting lift operating procedures.

Become familiar with all lift features and the proper operation of the lift components **before** attempting lift operation. Refer to the Lift Terminology section for identification of and description of lift components. Contact The Braun Corporation immediately if any of this information is not fully understood. Call 1-800-THE LIFT.

General Safety: Before operating the lift, always engage the vehicle transmission in Park "P" and engage the vehicle parking brake. Lift operators (attendants), wheelchair passengers and bystanders must keep clear of the area in which the power doors (if equipped), and the lift

Pre-Lift Operation Notes and Details

operates (clear of all moving parts). The lift occupant (passenger) must keep hands, arms and all other body parts within the lift

occupant area and clear of moving parts. Follow all lift operation and wheelchair passenger information detailed in this manual.

Control Switches

Pump Module Control Switches: The lift-mounted

control switches are color-coded and function-labeled to correspond to the color coding and switch-function labels that appear on the lift operating instructions decal. Triangular-shaped color-coded symbols (▲) appear on the lift operating instructions decal. The color of the symbol corresponds to the color of the switch to be used. The direction (point) of the symbol corresponds with the direction the switch should be activated (pressed) to produce the intended lift function.

▲ WARNING

Discontinue lift use immediately if any lift component does not operate properly. Failure to do so may result in serious bodily injury and/or property damage.

Press switches **upward**
for these functions:

Door(s)	Platform	
CLOSE	IN (Fold)	UP
▲ Yellow	▲ Orange	▲ Red



▼ Yellow	▼ Orange	▼ Red
OPEN	OUT (Unfold)	DOWN
Door(s)	Platform	

Press switches **downward**
for these functions:

Pre-Lift Operation Notes and Details

Handrail UP/DOWN Switch: A spring-loaded horizontal-slide style switch is built in the right (front) handrail. The handrail UP/DOWN switch activates the platform and the roll stop (same as pump-mounted UP/DOWN switch). Slide the switch knob out to the UP position to raise the platform. Slide the knob in to the

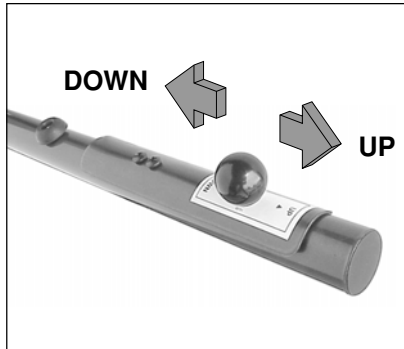

DOWN position to lower the platform.

Auxiliary Control Switches: A six-touch remote control system, a third station control, a hand-held control and an outside control station are available as **options**. All auxiliary controls activate lift functions and automatic door operators except the hand-held control. The hand-held control activates lift functions only.

Do not press lift-mounted switches and auxiliary control station switches at the same time. Do not attempt to interface aftermarket control systems.

Braun Corporation Aftermarket Control Systems Policy:

The Braun Corporation manufactures dedicated control systems for its products. These control systems have been designed and tested for use in conjunction with specific Braun products. Braun control systems are the **only** control systems authorized for use with Braun products.

Do not attempt to interface aftermarket control systems with Braun products. **To do so may result in serious bodily injury and/or property damage.**

Pre-Lift Operation Notes and Details

Lift Features

Bridge Plate: The hinged bridge plate assembly bridges the gap between the lift platform and the vehicle floor when the platform is positioned at floor level.

When the OUT (Unfold) switch is pressed and the platform unfolds

Fully-Unfolded (horizontal)
Bridge Plate (bridging position)



from stow position to floor level, the bridge plate is automatically deployed to the bridging (horizontal) position. When the IN (Fold) switch is pressed and the platform folds from deployed (horizontal) position to stowed position, the bridge plate folds (rotates) to the vertical position.

Automatic Floor Level Switching: When the platform unfolds from the stowed position, the platform stops automatically at floor level when fully unfolded. When raising the platform from ground level, the platform automatically stops at floor level when raised fully.

Although the VL955 features automatic floor level switching, the lift operator (wheelchair

passenger or attendant), **must view** the platform to **be certain** the platform is properly positioned at vehicle floor level and the bridge plate is properly positioned when a passenger is entering or exiting the vehicle. If the lift platform does not automatically stop at floor level as outlined, **discontinue lift operation immediately.**

Platform Assembly: The VL955 “stacking” platform assembly is made of an inboard platform section and an outboard platform section (each section consisting of a steel tubing frame with grating surface). The outboard platform section is equipped with the automatic roll stop.

Pre-Lift Operation Notes and Details

Fully-Folded Roll Stop (Up-vertical)

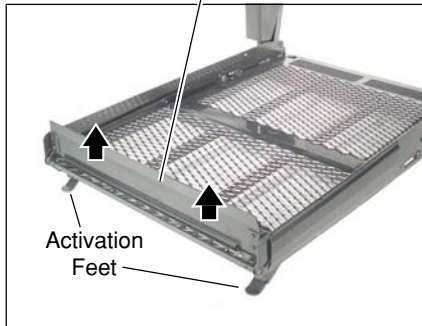

Fully-Unfolded Roll Stop (Ramp position)

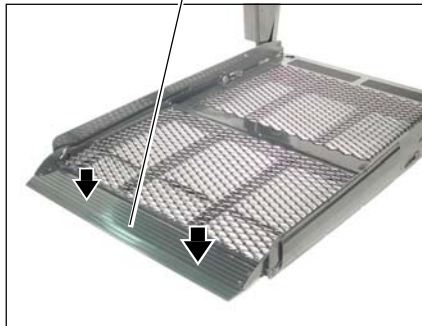

Automatic Outboard Roll Stop:

The outboard roll stop provides a ramp for wheelchair loading and unloading at ground level (see photos at left). When the platform lowers fully to ground level, the roll stop activation feet automatically unfold (rotate) the roll stop down to the ramp position (fully unfolded). The two activation feet (one at both ends of the roll stop) ensure roll stop operation on an uneven surface.

The roll stop is spring-loaded to automatically fold (rotate) to the vertical position when the UP switch is pressed. As the activation feet lift off the ground, the torsion springs rotate the roll stop to the vertical position.

Note: The platform raises

approximately two inches **before** the roll stop reaches the fully UP position. **Discontinue lift operation immediately if the roll stop does not operate properly.**

Outboard Roll Stop Operation:

The lift operator must press the DOWN switch to lower the platform fully to the ground. The lift operator or attendant **must view** the platform as it lowers to **be certain** the **entire platform** reaches and rests safely on the ground (see photo on page 16). Stop pressing the DOWN switch if any portion of the platform is obstructed while descending or the entire platform does not reach ground level **for any reason** (contact with an obstruction, mechanical failure, exceeding the lift “floor-to-ground” capacity, etc.).

Pre-Lift Operation Notes and Details

Lift Features (continued)

After the platform is fully lowered (entire platform reaches the ground), the roll stop **must remain in the fully unfolded**



The lift operator or attendant must **be certain** the **entire platform** reaches and rests safely on the ground.

(ramp) position until the entire wheelchair has crossed the roll stop when loading or unloading at ground level. When raising the platform, the lift operator **must view** the platform as it raises to **ensure** the roll stop rotates to the vertical position.

Bridging: The VL955 incorporates a bridging feature. This feature stops the down travel of the platform if the outboard end of the platform contacts a raised surface (such as a curb), preventing the operator from lowering the inboard end of the platform.

Handrails: Dual handrails are provided for wheelchair passenger (or standee) use. The handrails automatically unfold to the deployed position when the

platform unfolds and fold automatically to the stowed position when the platform folds. The passenger may choose to grip the handrails when on the lift platform (if applicable).

Note: The right (front) handrail is equipped with an UP/DOWN control switch (details in Control

⚠️ WARNING

Discontinue lift use immediately if any lift component does not operate properly. Failure to do so may result in serious bodily injury and/or property damage.

Pre-Lift Operation Notes and Details

Switches section). **Discontinue lift operation immediately if the handrails do not operate properly.**

Lift Passengers

Do not attempt to load or unload a passenger in a wheelchair or other apparatus that does not fit on the platform area. Do not exceed the 800 pound load capacity of the lift.

Passenger Orientation (Boarding Direction): The wheelchair passenger **must face outward** whenever on the platform.

The passenger must be positioned in the **center of the platform** to prevent side-to-side load imbalance. Other persons

should **not** ride on the platform with the wheelchair passenger. The wheelchair **brakes must be locked** and the roll stop must be in the **fully-up** (vertical) position **whenever a wheelchair passenger is on the platform.**

Do not use the outboard roll stop as a barrier (brake). Stop and brake the wheelchair when fully loaded on the platform. Manually stop and brake manual wheelchairs. Stop powered wheelchairs with the wheelchair controls. Turn powered (electric) wheelchairs off when on the platform.

Vehicle (Floor Level) Loading and Unloading: The platform **must be fully raised** (at floor level) and the bridge plate must be properly positioned when

loading or unloading a passenger in or out of the vehicle. Although the VL955 features automatic floor level switching, **it is the responsibility of the lift operator to ensure the platform and the bridge plate are properly positioned at floor level when loading and unloading passengers.**

If the roll stop, bridge plate, handrails or any other lift component does not operate as outlined in this manual, **discontinue lift use immediately** and contact your sales representative or call The Braun Corporation at 1-800-THE LIFT. One of our national Product Support representatives will direct you to an authorized service technician who will inspect your lift.

Pre-Lift Operation Notes and Details

Wheelchair-Equipped Occupant Seat Belts

The Braun Corporation recommends wheelchair passengers position and buckle their wheel-

chair-equipped seat belt (torso restraint) as specified by the manufacturer **before** loading onto a wheelchair lift.

Different types of disabilities require different types of wheelchairs and different types of wheelchair-equipped occupant restraint belt systems (torso restraint). It is the responsibility of the wheelchair passenger to have his or her wheelchair equipped with an occupant restraint (seat belt) under the direction of their health care professional.

Wheelchair lift attendants should be instructed on any special

needs and/or procedures required for safe transport of wheelchair passengers.

Operation Procedure Review

The Braun Corporation recommends that the wheelchair lift user and/or attendant review the safety precautions and operation procedures appearing in this manual and on lift-posted decals with your wheelchair lift sales representative, **before** attempting lift operation. Any questions or concerns can be answered by your sales representative at that time.

Using your own wheelchair, operate the lift through all functions and enter and exit the

WARNING

Position and secure (buckle, engage, fasten, etc.) the wheelchair-equipped occupant seat belt before loading onto the wheelchair lift platform. Failure to do so may result in serious bodily injury and/or property damage.

Pre-Lift Operation Notes and Details

vehicle with the sales representative on hand to ensure the lift is right for you as the end user (applicable for your use based on your physical abilities and the physical characteristics of your personal wheelchair). Become familiar with the proper operation of your lift before operating the lift by yourself.

This lift operator's **manual must be stored in the lift-mounted manual storage pouch when not in use.**

Preventive Maintenance

Maintenance is necessary to ensure safe and troublefree lift operation. Preventive lift maintenance consisting of **careful** inspections of your lift system and cleaning the lift should be a part of your routine. Simple inspections can detect potential lift operational problems.

Regular preventive maintenance will reduce potential lift operation downtime and increase the service life of the lift, as well as enhancing safety.

During routine inspections, operate the lift through a minimum of one complete cycle and note the following:

- Do the automatic door(s) open fully (if equipped)?
- Does the lift safely clear the door(s) when unfolding and folding?
- Do the lift control switches function properly?
- Does the automatic roll stop operate properly?
- Do the handrails function properly?
- Is the power source adequate or weak?

Exposure to harsh weather elements, environment conditions, or heavy usage, etc. may require more frequent maintenance and lubrication procedures.

Pre-Lift Operation Notes and Details

Preventive maintenance visual inspections **do not** take the place of the procedures specified in the Maintenance and Lubrication Schedule provided

in the applicable lift installation and service manual. Refer to the Maintenance and Lubrication section in this manual for further details.

WARNING

Maintenance and lubrication procedures must be performed by authorized service personnel as specified in the applicable installation/service manual. Failure to do so may result in serious bodily injury and/or property damage.

Lift Operating Instructions

WARNING

Read and become familiar with all lift operation safety precautions, pre-lift operation notes and details, operating instructions and manual operating instructions prior to operating the lift. If this information is not fully understood, contact The Braun Corporation immediately. Failure to do so may result in serious bodily injury and/or property damage.

WARNING

Whenever a passenger is on the platform, the:

- Passenger must face outward
- Wheelchair brakes must be locked
- Roll stop(s) must be UP

Failure to do so may result in serious bodily injury and/or property damage.

Before lift operation, park the vehicle on a level surface, away from vehicular traffic. Place the vehicle transmission in “Park” and engage the parking brake.

Photos appearing in the Lift Operating Instructions depict lift functions being activated by lift-mounted control switches only.

Lift-posted Warnings and Lift Operating Instructions decal 24069 provides lift operating instructions. Replace any missing, worn or illegible decals.

Follow the Manual Operating Instructions provided on pages 28-30 in event of power or equipment failure.

Lift Operating Instructions

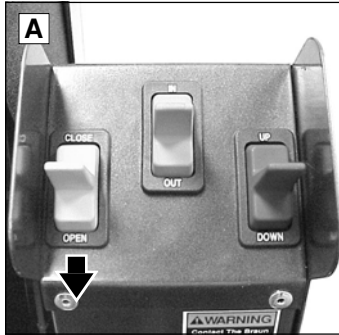

To Open Door(s):

Automatic Door Operator(s):

Press yellow OPEN switch until door(s) are **fully open**. Release switch.

Manual Door(s):

Manually open door(s) **fully** and secure.

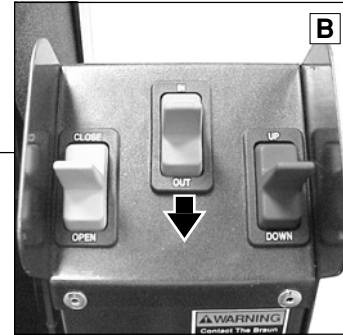

To Unfold Platform (Out):

Press orange OUT switch until platform **stops** (unfolds fully – reaches floor level). Release switch.



Lift Operating Instructions

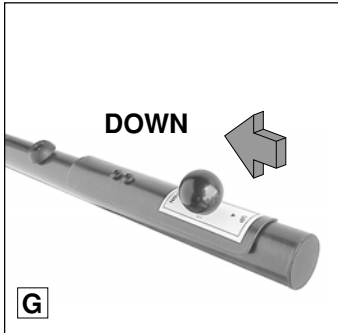

To Unload Passenger:

- 1. Read notes below! Load passenger onto platform **facing outward** and **lock** wheelchair brakes.

Note: Roll stop **must** be UP **before** loading passenger onto platform. **Lower head** to clear vehicle door jamb header.

- 2. Press red DOWN switch until the **entire** platform reaches ground level (stops) and roll stop unfolds **fully** (see Photos H and I). Release switch.

Handrail Switch: Slide knob in to DOWN position. See Photo G.

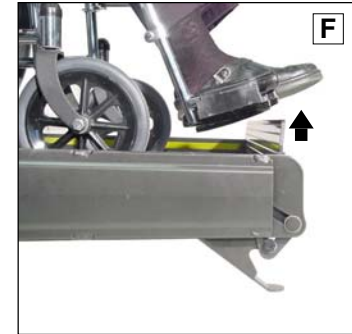

Lift Operating Instructions



To Unload Passenger: (continued)

3. Unlock wheelchair brakes and unload passenger from platform. ▶

Note: Roll stops **must** be **fully unfolded** (ramp position) until the entire wheelchair has crossed the roll stop. See Photos K and L.

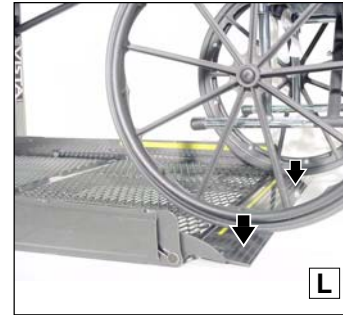
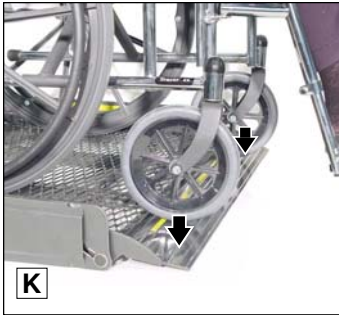

Lift Operating Instructions

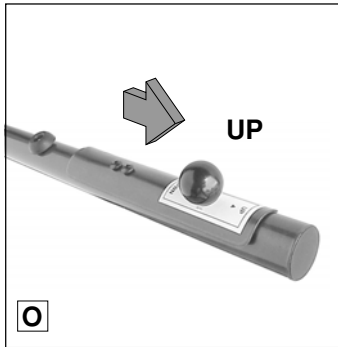

To Load Passenger:

1. Load passenger onto platform **facing outward** and **lock wheelchair brakes**.

Note: Roll stops **must** be **fully unfolded** (ramp position) until the entire wheelchair has crossed the roll stop. See Photos K and L.

2. Press red UP switch until platform stops (reaches floor level). Release switch.

- Handrail Switch: Slide knob out to UP position.

Note: Roll stop **must** be UP **before** raising platform. Platform will raise above ground level approximately two inches **before** the roll stop reaches the fully UP position.

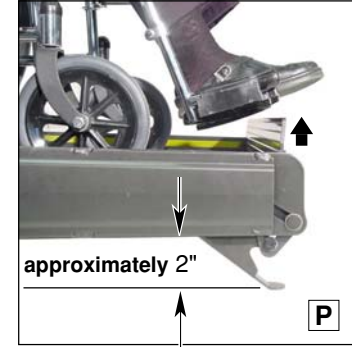

Lift Operating Instructions



To Load Passenger (continued):

3. Unlock wheelchair brakes and load passenger from platform into vehicle. **Note:** Lower head to clear door jamb header.

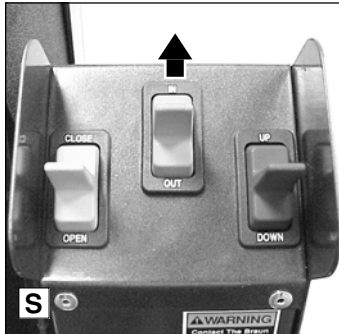

To Fold Platform (In):

- Press orange IN switch until platform **stops** (fully folded). Release switch.



Lift Operating Instructions

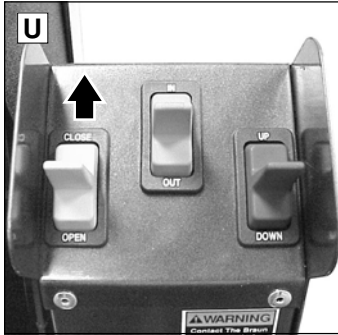

To Close Door(s):

Automatic Door Operator(s):

- ◀ Press yellow CLOSE switch until door(s) are **fully closed**. Release switch.

Manual Door(s):

- Manually close door(s) **fully**.

Manual Operating Instructions

If you experience power or equipment failure, refer to the Manual Operating Instructions to operate the lift. Instructions and photos are provided for all steps that differ

from standard lift operation procedures. Manual Instructions Decal 27146 (posted on pump cover) provides manual operating instructions also. Refer to the Lift Operat-

ing Instructions for all normal lift operation procedures (such as loading and unloading passengers). **Follow all Lift Operation Safety Precautions!**



Note: Close backup pump release valve securely **before** operating electric pump.

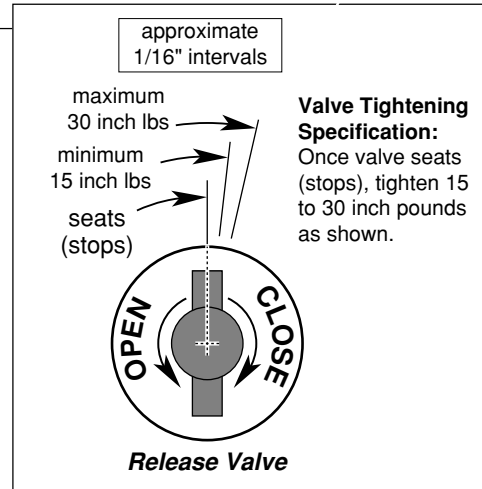

Manual Operating Instructions

Refer to photos and illustration of release valve on previous page.



To Unfold Platform (Out):

Using hand pump handle (Photo B):

- Place slotted end of pump handle onto backup pump release valve and turn **counterclockwise** (open — **1/2 turn only**) until the platform reaches **floor level (fully unfolded)**. See Photo C.
- Turn the release valve **clockwise** (close) to stop the platform. See Photo C.

Note: Valve must be tight, but **do not** overtighten.

DOWN • To Lower Platform:
• To Unfold Roll Stop:

Place slotted end of pump handle onto backup pump release valve

and turn **counterclockwise** (open — **1/2 turn only**) until the platform reaches ground level and/or roll stop unfolds.

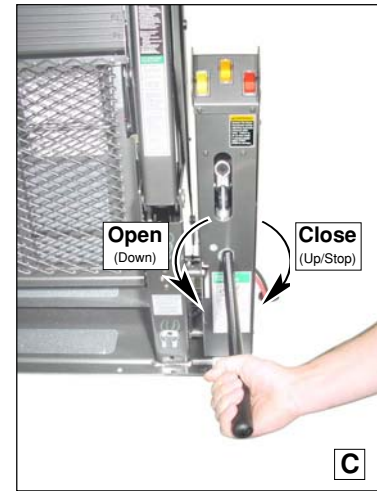

Manual Operating Instructions

Refer to photos and illustration of release valve on page 28.

UP

- To Fold Roll Stop:
- To Raise Platform:

Note: Close backup pump release valve securely **before** operating electric pump.

Using hand pump handle:

- Place slotted end of pump handle onto backup pump release valve and turn **clockwise** to close securely. See Photo D.

Note: Valve must be tight, but **do not** overtighten.

- Insert handle into backup pump and stroke until platform reaches **floor level** (see Photo E).

To Fold Platform (In):

Insert handle into backup pump and stroke until platform **stops** (folds **fully**). See Photo E.

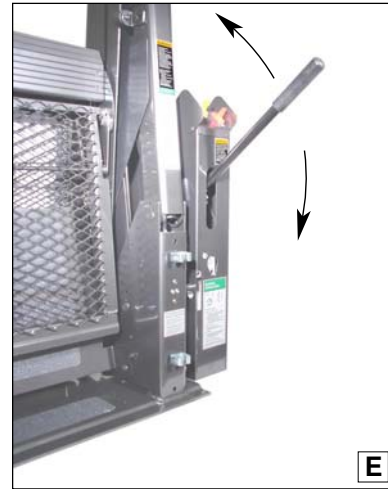
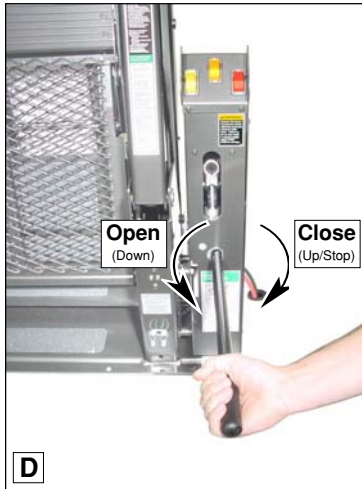

Decals and Antiskid

⚠️ WARNING

Replace missing, worn or illegible decals. Failure to do so may result in serious bodily injury and/or property damage.

Note: Clean surfaces as detailed on opposite page before posting decals.

⚠️ WARNING

Lift installation and servicing prohibited by anyone who has not been certified by The Braum Corporation Sales and Service School. Certified service technicians should call 1-800-THE LIFT to receive applicable installation/service manual. Failure to follow this policy may result in serious bodily injury and/or property damage.

25675

⚠️ WARNING

Contact The Braum Corporation before adjusting hydraulic pressure relief valve. Failure to do so may result in serious bodily injury and/or property damage.

22249

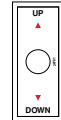

26701

Microswitch Adjustment Instructions

Unfold/Down (Outside) Microswitch
Turn adjustment bolt clockwise to stop platform unfold function corner. Turn adjustment bolt counter-clockwise to allow platform to unfold further.

Up/Fold (Inside) Microswitch
Turn adjustment bolt counter-clockwise to stop platform raise function corner. Turn adjustment bolt clockwise to allow platform to raise further.

24490

THE BRAUM CORPORATION

Providing Access to the World Since 1972

ADA COMPLIANT STANDARDS AUSTRALIA

25652

Decals

The lift is only as safe as the operator. Replace any missing, worn or illegible decals! Part numbers are provided for decals. Inspect your lift for missing, worn or illegible decals. Call 1-800-THE LIFT for replacements.

29048

24069

⚠️ WARNING

- Read manual before opening lift.
- Level and unfold on level surface only.
- Engage vehicle parking brake before operating lift.
- Provide adequate clearance (distance of vehicle to wheelchair).
- Do not operate lift if you suspect lift damage, wear or any abnormal condition.
- Load capacity and byproducts clear of area in which lift operates.

Whenever a wheelchair passenger is on the platform, the passenger must face forward.

- Wheelchair brakes must be locked.
- Roll stop must be up.
- Failure to follow these rules may result in serious bodily injury and/or property damage.

LIFT OPERATING INSTRUCTIONS

TO OPEN DOOR(S):

- Press **UP** OR **DOWN** switch until platform stop (s) are fully open.

TO UNLOAD PLATFORM (OUT):

- Press **OUT** switch until platform stops (reaches floor level).

TO UNLOAD PASSENGER:

- Lead passenger onto platform facing downward and lock wheelchair brakes.
- Press **DOWN** switch until platform stops and roll stop unfolds fully.
- Unlock wheelchair brakes and attend passenger from platform.

TO LOAD PASSENGER:

- Lead passenger onto platform facing upward and lock wheelchair brakes.
- Press **UP** switch until platform stops and roll stop unfolds fully.
- Unlock wheelchair brakes and attend passenger from platform.

TO FOLD PLATFORM (IN):

- Press **IN** switch until platform stops.

TO CLOSE DOOR(S):

- Press **CL** (Close) switch until door(s) are fully closed.

12375

Parking Courtesy Requested

THE BRAUM CORPORATION

Providing Access to the World

1-800-THE LIFT

27146

MANUAL OPERATION

Using hand pump handle:

TO UNFOLD PLATFORM (OUT):

- Close hand pump valve (turn clockwise).
- Insert handle in pump and stroke until platform folds fully (stops).
- Open hand pump valve (turn counter-clockwise) until platform reaches floor level. Open 1/2 turn only.
- Close hand pump valve (turn clockwise).

DOWN (TO COVER):

- Open hand pump valve (turn counter-clockwise). Open 1/2 turn only.

UP (TO RAISE):

- Close hand pump valve (turn clockwise).
- Insert handle in pump and stroke until platform reaches floor level.

TO FOLD PLATFORM (IN):

- Insert handle in pump and stroke.

Close valve before operating electric pumps.

Decals and Antiskid

Antiskid

Inspect your lift for any missing or worn antiskid. Order as needed.

Available Antiskid		
Size	Color	Part No.
2" x 12"	Black	#24172-BK
2" x 12"	Yellow	#24172-YL
3" x 12"	Black	#24173-BK
3" x 12"	Yellow	#24173-YL
6" x 12"	Black	#24174-BK
6" x 12"	Yellow	#24174-YL

WARNING

Replace missing or worn antiskid. Failure to do so may result in serious bodily injury and/or property damage.

Note: Clean surfaces with isopropyl alcohol before decal or antiskid application. Use a clean cloth or paper towels. **Do not** use oily shop rags. Wipe surface free of residue with dry portion of cleaning cloth.

Maintenance and Lubrication

Maintenance is necessary to ensure safe and troublefree lift operation. General preventive maintenance consisting of inspections of your lift system and cleaning the lift should be a part of your routine.

The VL955 has been designed with many self-lubricating components. Lubricate the pivot points specified on page 34 approximately every four weeks (or 400 cycles) with a light penetrating type oil (30 weight or equivalent). Severe conditions (weather, environment, heavy usage, etc.) may require more frequent lubrication.

Preventive maintenance visual inspections and lubrication procedures **do not** take the place

of the procedures specified in the Maintenance and Lubrication Schedule provided in the applicable lift installation and service manual. The procedures outlined in the Maintenance and Lubrication Schedule **must be performed at the recommended scheduled intervals by an authorized Braun Corporation service representative who has attended and been certified by The Braun Corporation Sales and Service School.**

If the scheduled maintenance and lubrication procedures are not being performed, or if there is any sign of lift damage, wear, abnormal condition or improper operation, **discontinue lift use immediately.** Contact your sales representative or call The Braun

Corporation at 1-800-THE LIFT. One of our national Product Support representatives will direct you to an authorized service technician who will inspect your lift.

WARNING

Maintenance and lubrication procedures must be performed by authorized service personnel as specified in the applicable installation/service manual. Failure to do so may result in serious bodily injury and/or property damage.

Maintenance and Lubrication

Note: LPS2 General Purpose Penetrating Oil is available in eleven ounce aerosol cans from The Braun Corporation (part number 15807).

Note: Clean lubrication points **before** applying lubricant.

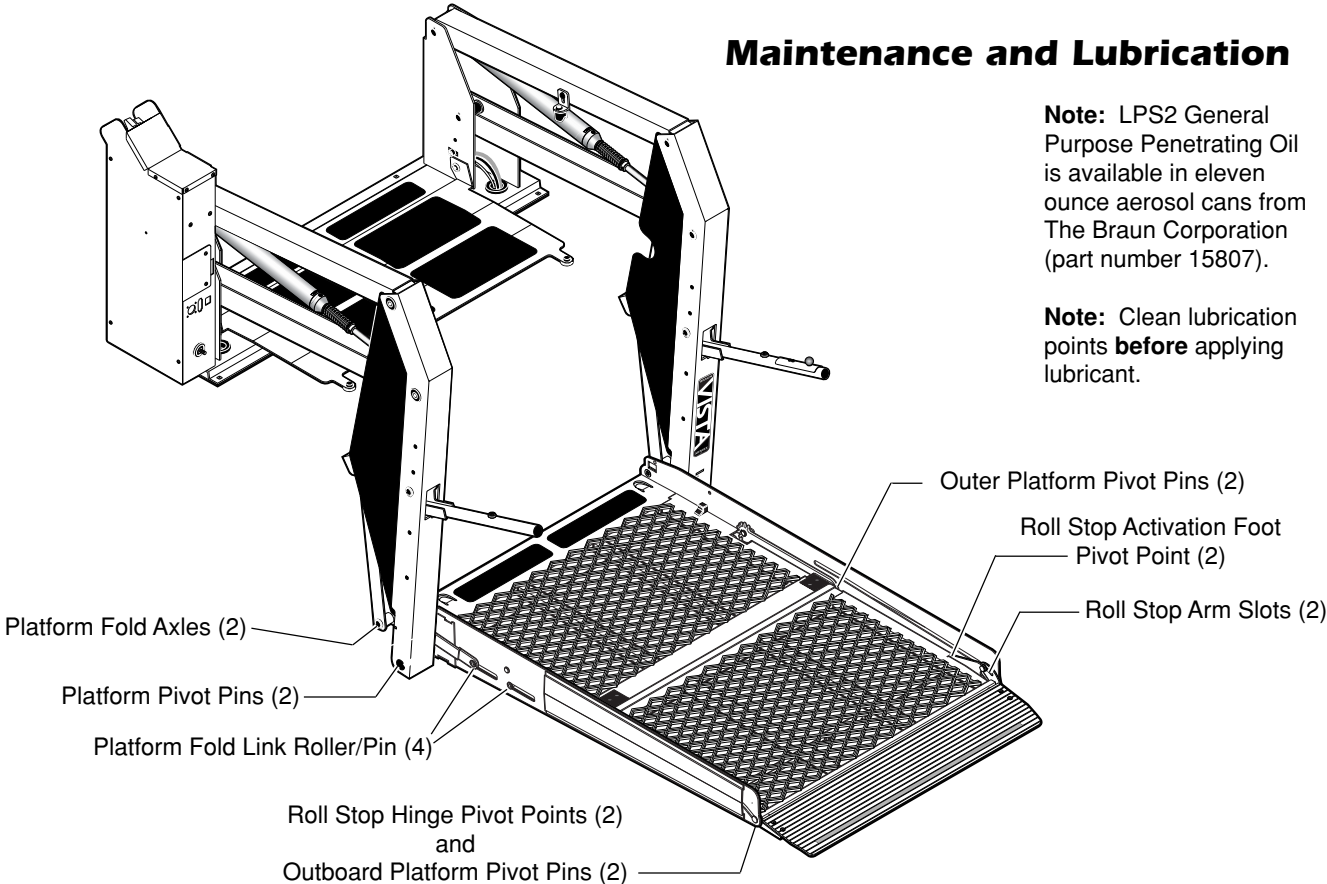

Warranty and Registration Instructions

Immediately upon receiving your lift, examine the unit for any damage. Notify the carrier at once with any claims.

Two warranty/registration cards (shown below) are located in the lift-mounted owner's manual storage pouch. The sales representative must process one of the

cards. The consumer must fill out the other card and mail it to The Braun Corporation. The warranty is provided on the back cover of this manual. The **warranty cards must be processed to activate the warranty.**

The Braun Serial No./Series No. identification tag (shown below) is

located on the opposite pump side tower. This I.D. tag contains the product identification information provided on the Warranty/Registration card. Record the information in the space provided on the next page. **This information must be provided when filing a warranty claim or ordering parts.**

Series No. Pump Code
Model No. Serial No. Cylinder Code

OWNER'S WARRANTY REGISTRATION	
VL955U3144-02-00101-39-14CF	
PURCHASED FROM _____	
OWNER _____	
NAME _____	DATE INSTALLED _____
ADDRESS _____	
CITY _____	
TELEPHONE _____	STATE _____ ZIP _____
<small>TO VALIDATE WARRANTY REGISTRATION CARDS MUST BE RETURNED TO THE BRAUN CORPORATION.</small>	

Sample Warranty/Registration Card

The Braun Corporation PO Box 310 Winamac, IN 46996 (574) 946-6153	
LIFT MODEL #	
VL955U3144	
SERIAL NUMBER	
02-00101	
PUMP CODE	CYLINDER
39	14CF
MFG DATE	
10/14/2003	
<small>PATENT PENDING 5,261,779-6,965,924-6,238,169-6,454,447</small>	

Sample Serial No./Series No. Identification Tag

Warranty and Registration Instructions

Model No. _____ Pump Code _____

Series No. _____ Cylinder Code _____

Serial No. _____ Date of Manufacture _____

Note: This information **must be provided** when filing a warranty claim or ordering parts. Keep for future use.

"Providing Access to the World"[®]



**Over 300 Braun
Dealers Worldwide**

VL955

Vista Series™
Consumer Wheelchair Lifts

Operator's Manual

Braun Limited Warranty

Consult your local Braun dealer regarding warranty policy.

www.braunlift.com/international

Operator's Manual

VL955

Vista Series™
Commercial Wheelchair Lifts

BRAUN
VISTA
SERIES

VL955 Vista Series™

All illustrations, descriptions and specifications in this manual are based on the latest product information available at the time of publication. The Braun Corporation reserves the right to make changes at any time without notice.